

G6C

PCB Power Relay

Miniature High Capacity Relays with SPST-NO 10A and SPST-NO + SPST-NC 8A

- SPST-NO 10A and SPST-NO + SPST-NC 8A for power switching and output that satisfy the needs for space-saving.
- Small High-capacity Relays Compact: 20 × 15 × 10 mm (L × W × H).
- Low power consumption: 200 mW.
- Ultrasonically cleanable models is available.
- Exclusive P6C model for sockets is now available.

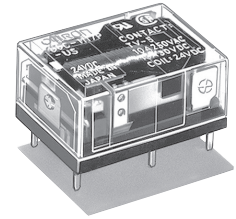
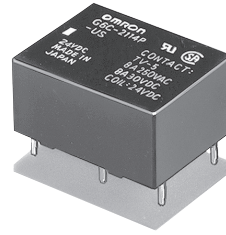

Model Number Legend

G6C- - - - - -
 1 2 3 4 5 6 7 8 9

1. Relay Function

- None: Single-side stable
U : Single-winding latching
K : Double-winding latching

2. Contact Form

- 11: SPST-NO (1a)
21: SPST-NO (1a) + SPST-NC (1b)

3. Contact Type

- 1: Single

4. Enclosure rating

- 4: Fully sealed
7: Flux protection

5. Terminal Shape

- P: PCB terminals
 Socket mounting Terminals
C: Self-clinching PCB

6. Contact Material

- None: Standard (Ag-alloy (Cd free))
FD : AgSnIn Contacts
 (Suitable for DC inductive load
 with high inrush current)

7. Approved Standards

- US: UL/CSA

8. Washability

- None: Standard model
 (not compatible with ultrasonically
 cleanable models)
U : For ultrasonically cleanable

9. Mounting

- None: Mounted directly to PCB
P6C : Mounted to Socket

Application Examples

Ideal for output applications of control equipments

G
6
C

Ordering Information

Standard Models (UL, CSA certified)

Enclosure rating	Contact form	Relay Function Terminals	Single-side stable		Single-winding latching		Double-winding latching		Minimum packing unit
			Model	Rated coil voltage	Model	Rated coil voltage	Model	Rated coil voltage	
Flux protection	SPST-NO (1a)	Straight PCB	G6C-1117P-US	3 VDC	G6CU-1117P-US	3 VDC	G6CK-1117P-US	3 VDC	100 pcs/ tray
				5 VDC		5 VDC		5 VDC	
				6 VDC		-		6 VDC	
				12 VDC		12 VDC		12 VDC	
				24 VDC		24 VDC		24 VDC	
			5 VDC	G6CU-1117P-FD-US	G6CK-1117P-FD-US	-			
		12 VDC	12 VDC						
		24 VDC	24 VDC						
		Self-clinching PCB	G6C-1117C-US	3 VDC	-	-	G6CK-1117C-US	-	
				5 VDC	-	-		-	
				12 VDC	-	-		12 VDC	
				24 VDC	-	-		24 VDC	
	3 VDC			G6CU-2117P-US	G6CK-2117P-US	3 VDC			
	5 VDC		5 VDC						
	6 VDC	6 VDC							
	12 VDC	12 VDC							
	24 VDC	24 VDC							
	SPST-NO (1a) + SPST-NC (1b)	Straight PCB	G6C-2117P-US	5 VDC	G6CU-2117P-FD-US	G6CK-2117P-FD-US	5 VDC		
				12 VDC			12 VDC		
				24 VDC			24 VDC		
				5 VDC			-	-	
				12 VDC			-	-	
			24 VDC	-	-				
		Self-clinching PCB	G6C-2117C-US	3 VDC	G6CU-2117C-US	G6CK-2117C-US	3 VDC		
5 VDC				5 VDC					
6 VDC				-			-		
12 VDC				12 VDC					
24 VDC				24 VDC					
3 VDC			-	-					

Enclosure rating	Contact form	Relay Function Terminals	Single-side stable		Single-winding latching		Double-winding latching		Minimum packing unit	
			Model	Rated coil voltage	Model	Rated coil voltage	Model	Rated coil voltage		
Fully sealed	SPST-NO (1a)	Straight PCB	G6C-1114P-US	3 VDC	G6CU-1114P-US	G6CK-1114P-US	3 VDC	100 pcs/ tray		
				5 VDC			5 VDC		5 VDC	
				6 VDC			6 VDC		6 VDC	
				12 VDC			12 VDC		12 VDC	
				24 VDC			24 VDC		24 VDC	
			5 VDC	G6CU-1114P-FD-US	G6CK-1114P-FD-US	-				
		12 VDC	12 VDC							
		24 VDC	24 VDC							
		Self-clinching PCB	G6C-1114C-US	3 VDC	G6CU-1114C-US	G6CK-1114C-US	3 VDC			
				5 VDC			-		-	5 VDC
				12 VDC			12 VDC		12 VDC	
				24 VDC			-		-	24 VDC
	3 VDC			G6CU-2114P-US			G6CK-2114P-US		3 VDC	
	5 VDC		5 VDC							
	6 VDC	6 VDC								
	12 VDC	12 VDC								
	24 VDC	24 VDC								
	SPST-NO (1a) + SPST-NC (1b)	Straight PCB	G6C-2114P-US	5 VDC	G6CU-2114P-FD-US	G6CK-2114P-FD-US	-			
				12 VDC			12 VDC			
				24 VDC			24 VDC			
				5 VDC			-		-	
				12 VDC			-		-	
			24 VDC	-	-					
		Self-clinching PCB	G6C-2114C-US	3 VDC	G6CU-2114C-US	G6CK-2114C-US	3 VDC			
5 VDC				5 VDC						
6 VDC				-			-	6 VDC		
12 VDC				-			-	12 VDC		
24 VDC				-			-	24 VDC		
3 VDC			-	-						

Note. When ordering, add the rated coil voltage to the model number.

Example: G6C-1117P-US DC3

DC3 — Rated coil voltage

However, the notation of the coil voltage on the product case as well as on the packing will be marked as □□ VDC.

● Ultrasonically Cleanable Models (UL, CSA certified)

Enclosure rating	Relay Function		Single-side stable		Single-winding latching		Double-winding latching		Minimum packing unit
	Contact form	Terminals	Model	Rated coil voltage	Model	Rated coil voltage	Model	Rated coil voltage	
Fully sealed	SPST-NO (1a)	Straight PCB	G6C-1114P-US-U	3 VDC	G6CU-1114P-US-U	–	G6CK-1114P-US-U	–	100 pcs/ tray
				5 VDC		5 VDC		5 VDC	
				6 VDC		–		–	
				12 VDC		12 VDC		12 VDC	
				24 VDC		–		24 VDC	
		–	–	–					
	Self-clinching PCB	G6C-1114C-US-U	12 VDC	–	–	–			
			24 VDC	–	–	–			
	SPST-NO (1a) + SPST-NC (1b)	Straight PCB	G6C-2114P-US-U	5 VDC	–	–	G6CK-2114P-US-U	5 VDC	
				12 VDC				12 VDC	
				24 VDC				–	
		Self-clinching PCB	G6C-2114C-US-U	5 VDC	–	–	–	–	
12 VDC				–					
24 VDC				–					

Note. When ordering, add the rated coil voltage to the model number.

Example: G6C-1114P-US-U DC3

DC3 — Rated coil voltage

However, the notation of the coil voltage on the product case as well as on the packing will be marked as □□ VDC.

● Connecting Sockets (Sold Separately)

Applicable relays	Model	Minimum packing unit
G6C-2114P-US-P6C G6C-2117P-US-P6C G6C-1114P-US-P6C G6C-1117P-US-P6C G6CU-2114P-US-P6C G6CU-2117P-US-P6C G6CU-1114P-US-P6C G6CU-1117P-US-P6C	P6C-06P	20 pcs/tube
G6CK-2114P-US-P6C G6CK-2117P-US-P6C G6CK-1114P-US-P6C G6CK-1117P-US-P6C	P6C-08P	
Removal Tool	P6B-Y1	1
Hold-down Clips	P6B-C2	

Note 1. Use the G6C-□□□□P-US-P6C to mount to a P6C Socket.

Note 2. When using by combining sockets, the rated current will be 5A due to its rated switching current.

■ Ratings

Coil: 1-Pole, Single-side Stable Type (Including models for ultrasonically cleanable)

Item	Rated current (mA)	Coil resistance (Ω)	Must operate voltage (V)	Must release voltage (V)	Max. voltage (V)	Power consumption (mW)
Rated voltage			% of rated voltage			
3 VDC	67	45	70% max.	10% min.	160% (at 23°C)	Approx. 200
5 VDC	40	125				
6 VDC	33.3	180				
12 VDC	16.7	720				
24 VDC	8.3	2,880				

Coil: Single-winding Latching Type (Including models for ultrasonically cleanable)

Item	Rated current (mA)	Coil resistance (Ω)	Must set voltage (V)	Must reset voltage (V)	Max. voltage (V)	Power consumption	
						Set coil (mW)	Reset coil (mW)
Rated voltage			% of rated voltage				
3 VDC	67	45	70% max.	70% max.	160% (at 23°C)	200	200
5 VDC	40	125					
6 VDC	33.3	180					
12 VDC	16.7	720					
24 VDC	8.3	2,880					

Coil: Double-winding Latching Type (Including models for ultrasonically cleanable)

Item	Rated current (mA)		Coil resistance (Ω)		Must set voltage (V)	Must reset voltage (V)	Max. voltage (V)	Power consumption	
	Set coil	Reset coil	Set coil	Reset coil				Set coil (mW)	Reset coil (mW)
Rated voltage			% of rated voltage						
3 VDC	93.5	93.5	32.1	32.1	70% max.	70% max.	130% (at 23°C)	280	280
5 VDC	56.0	56.0	89.3	89.3					
6 VDC	46.7	46.7	129	129					
12 VDC	23.3	23.3	514	514					
24 VDC	11.7	11.7	2,056	2,056					

Note 1. The rated current and coil resistance are measured at a coil temperature of 23°C with a tolerance of ±10%.

2. The operating characteristics are measured at a coil temperature of 23°C.

3. The "Max. voltage" is the maximum voltage that can be applied to the relay coil.

Contact

Contact Form	SPST-NO (1a)		SPST-NO (1a) + SPST-NC (1b)	
	Resistive load	Inductive load (cosφ = 0.4; L/R = 7 ms)	Resistive load	Inductive load (cosφ = 0.4; L/R = 7 ms)
Rated load	10 A (8 A) at 250 VAC 10 A (10 A) at 30 VDC	5 A (5 A) at 250 VAC 5 A (5 A) at 30 VDC	8 A (8 A) at 250 VAC 8 A (8 A) at 30 VDC	3.5 A (3.5 A) at 250 VAC 3.5 A (3.5 A) at 30 VDC
Item				
Contact type	Single			
Contact material	Ag-Alloy (Cd free)			
Rated carry current	10 A (10 A)		8 A (8 A)	
Max. switching voltage	380 VAC, 125 VDC			
Max. switching current	10 A (10 A)		8 A (8 A)	

Note. The values shown in parentheses () are for -FD models only.

Characteristics (Including models for ultrasonically cleanable)

Item	Classification	Single-side Stable	Single-winding Latching	Double-winding Latching
Contact resistance *1		30 mΩ max.		
Operate (set) time		10 ms max.		
Release (reset) time		10 ms max.		
Min. set pulse width		-	20 ms (at 23°C)	
Min. reset pulse width		-	20 ms (at 23°C)	
Insulation resistance *2	Between coil and contacts	1,000 MΩ min.		
	Between contacts of the same polarity	1,000 MΩ min.		
	Between contacts of different polarity	1,000 MΩ min. (SPST-NO, SPST-NC)		
	Between set and reset coils	-	-	1,000 MΩ min.
Dielectric strength	Between coil and contacts	2,000 VAC 50/60Hz for 1min		
	Between contacts of the same polarity	1,000 VAC 50/60Hz for 1min		
	Between contacts of different polarity	2,000 VAC 50/60Hz for 1min (SPST-NO, SPST-NC)		
	Between set and reset coils	-	-	250 VAC 50/60Hz for 1min
Vibration resistance	Destruction	10 to 55 to 10 Hz, 0.75 mm single amplitude (1.5 mm double amplitude)		
	Malfuction	10 to 55 to 10 Hz, 0.75 mm single amplitude (1.5 mm double amplitude)		
Shock resistance	Destruction	1,000 m/s ²		
	Malfuction	100 m/s ²		
Durability	Mechanical	50,000,000 operations min. (at 18,000 operations/hr)		
	Electrical	100,000 operation min. (at 1,800 operations/hr under rated load)		
Failure rate (P level) (reference value) *3		10 mA at 5 VDC		
Ambient operating temperature		-25°C to 70°C (with no icing or condensation)		
Ambient operating humidity		5% to 85%		
Weight		Approx. 5.6 g		

Note. The given values are initial values.

*1. Measurement conditions: 5 VDC, 1 A, voltage drop method.

*2. Testing conditions: measured with a 500 VDC megohmmeter (at 250 VDC between set/reset coil).

*3. This value was measured at a switching frequency of 120 operations/min.

G
6
C

Engineering Data

Maximum Switching Capacity

G6C-1114□-US

G6C-1117□-US

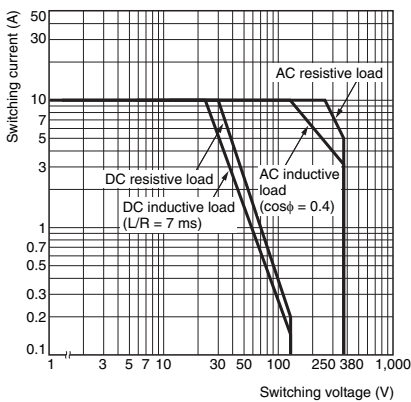

G6C-1114□-FD-US

G6C-1117□-FD-US

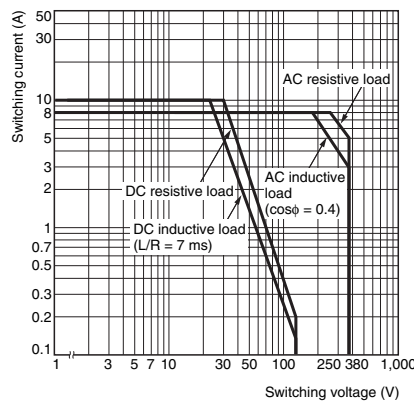

G6C-2114□-US

G6C-2117□-US

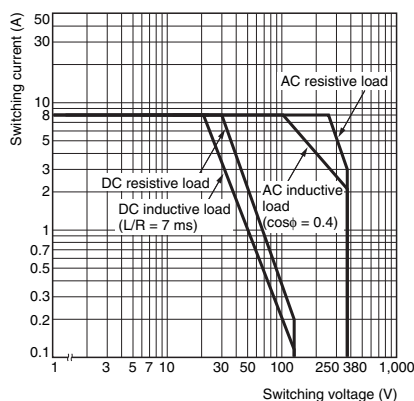

G6C-2114□-FD-US

G6C-2117□-FD-US

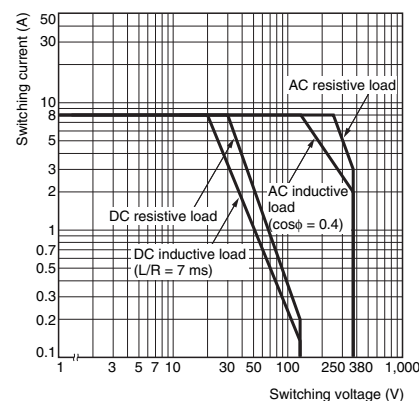

● Durability

G6C-1114□-US, G6C-2114□-US
G6C-1117□-US, G6C-2117□-US

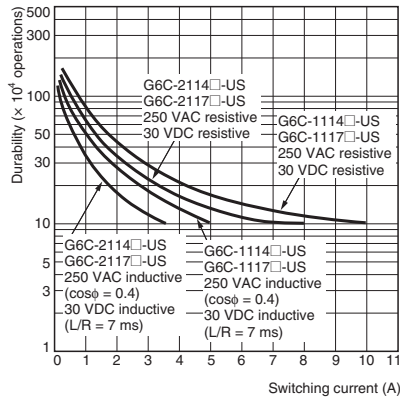

G6C-1114□-FD-US, G6C-2114□-FD-US
G6C-1117□-FD-US, G6C-2117□-FD-US

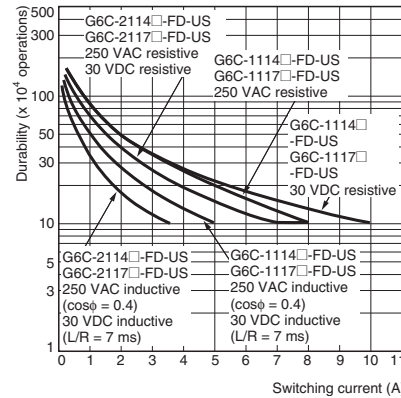

● Ambient Temperature vs. Maximum Coil Voltage

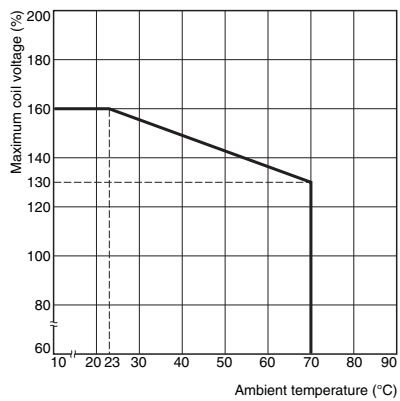

Note. The maximum coil voltage refers to the maximum value in a varying range of operating power voltage, not a continuous voltage.

● Ambient Temperature vs Must Operate and Must Release voltages

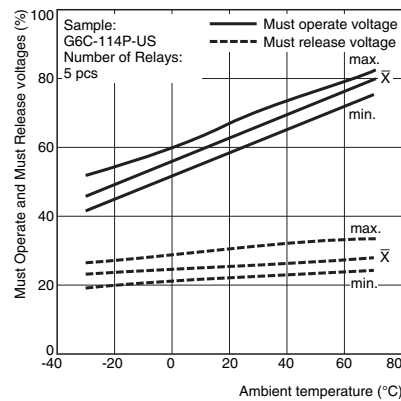

● Shock Malfunction

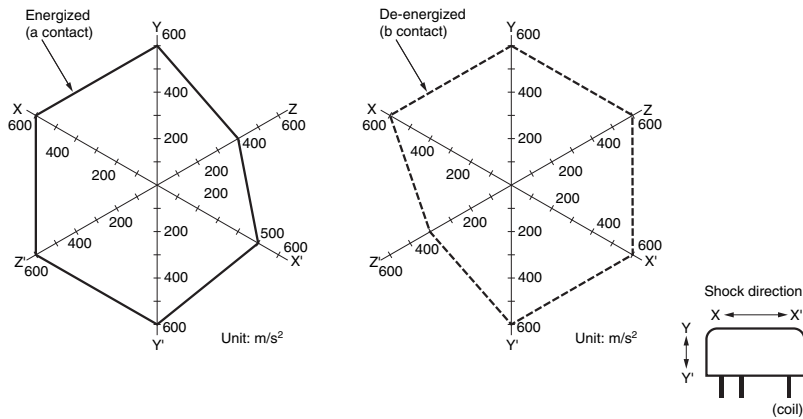

Sample: G6C-2114P-US DC24V
Number of Relays: 6 pcs
Test conditions: Shock is applied in $\pm X$, $\pm Y$, and $\pm Z$ directions three times each with without energizing the Relays to check the number of malfunctions.
Requirement: 100 m/s^2

● Magnetic Interference (between Relays)

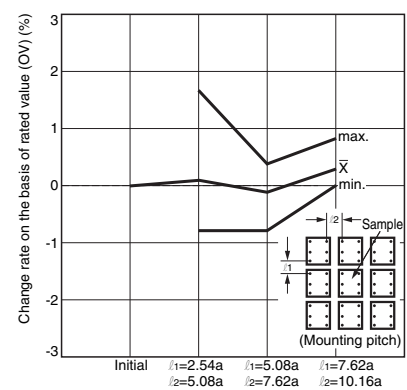

■Dimensions

Flux Protection Model (Straight PCB) G6C-□117P (-FD) -US

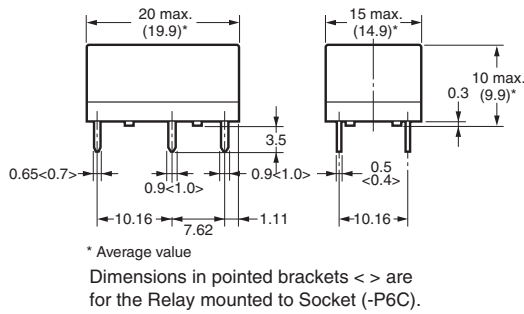
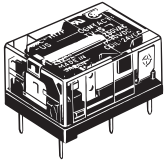

PCB Mounting Holes (Bottom View) Tolerance: ±0.1

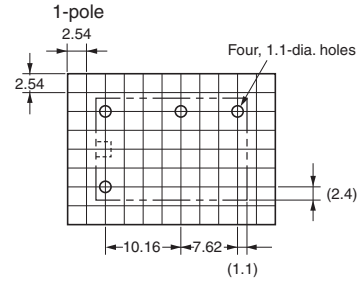

Terminal Arrangement/ Internal Connections (Bottom View)

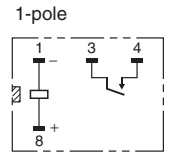

Flux Protection Model (Self-clinching PCB) G6C-□117C-US

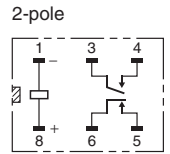
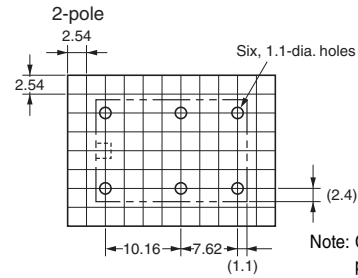
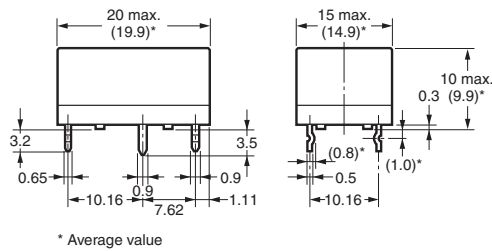
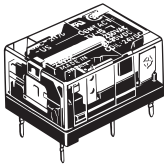

Note: Check carefully the coil polarity of the Relay.

Fully Sealed Model (Straight PCB) G6C-□114P (-FD) -US

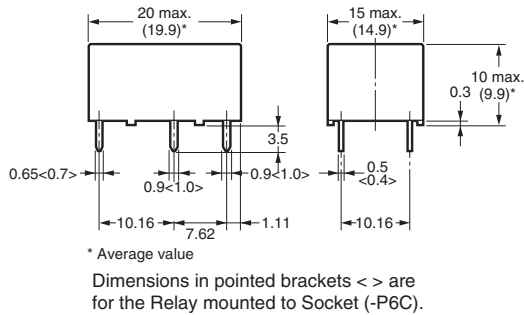
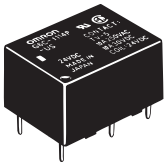

PCB Mounting Holes (Bottom View) Tolerance: ±0.1

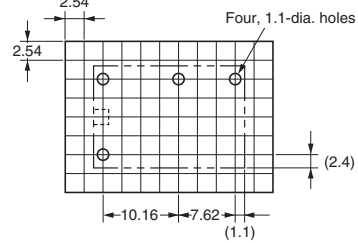

Terminal Arrangement/ Internal Connections (Bottom View)

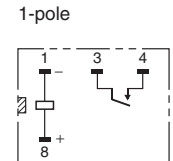

Fully Sealed Model (Self-clinching PCB) G6C-□114C-US

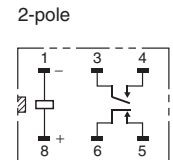
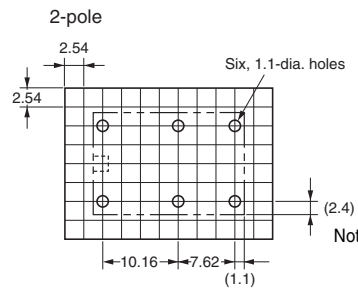
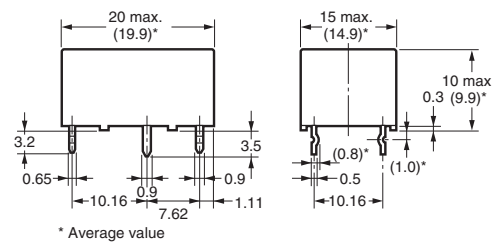
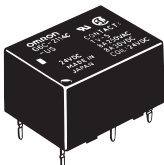

Note: Check carefully the coil polarity of the Relay.

Note: Orientation marks are indicated as follows: □ □

**Flux Protective
Single-winding Latching Model
(Straight PCB)
G6CU-□117P (-FD) -US**

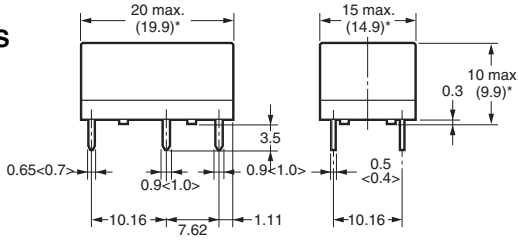
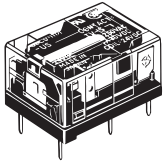

* Average value
Dimensions in pointed brackets < > are for the Relay mounted to Socket (-P6C).

**PCB Mounting Holes
(Bottom View)
Tolerance: ±0.1**

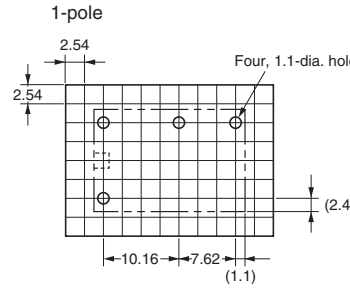

**Terminal Arrangement/
Internal Connections
(Bottom View)**

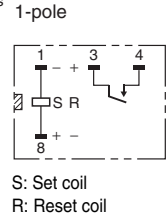

**Flux Protective
Single-winding Latching Model
(Self-clinching PCB)
G6CU-□117C-US**

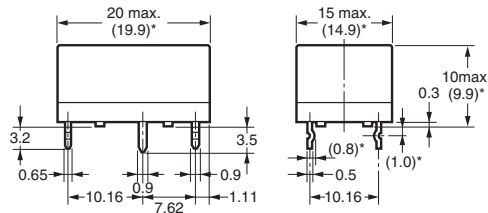
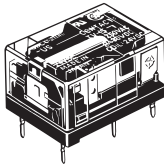

* Average value

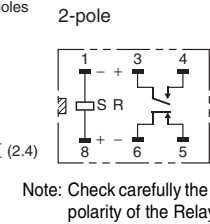
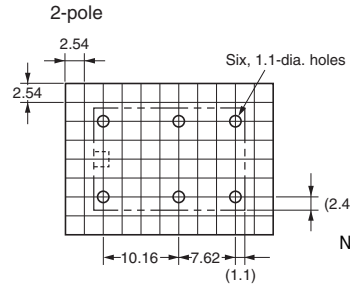

**Fully Sealed Model
Single Latching Models
(Straight PCB)
G6CU-□114P (-FD) -US**

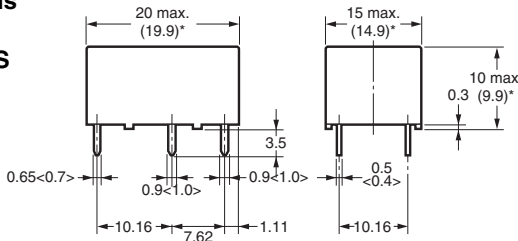
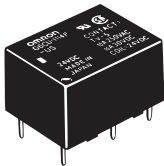

* Average value
Dimensions in pointed brackets < > are for the Relay mounted to Socket (-P6C).

**PCB Mounting Holes
(Bottom View)
Tolerance: ±0.1**

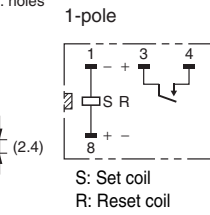
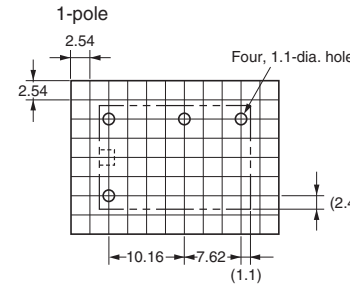

**Fully Sealed Model
Single Latching Models
(Self-clinching PCB)
G6CU-□114C-US**

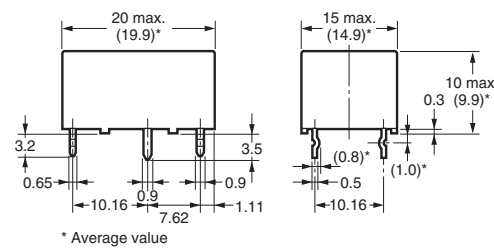
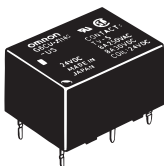

* Average value

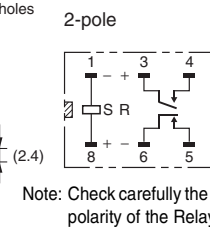
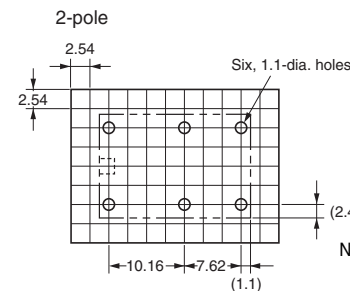

Note: Orientation marks are indicated as follows: □

**Flux Protective
Double-winding Latching Model
(Straight PCB)
G6CK-□117P (-FD) -US**

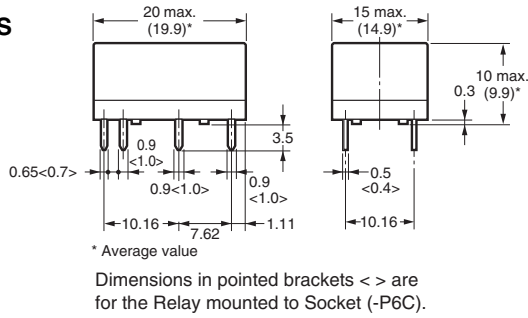
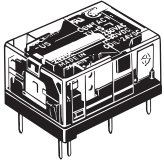

**PCB Mounting Holes
(Bottom View)
Tolerance: ±0.1**

**Terminal Arrangement/
Internal Connections
(Bottom View)**

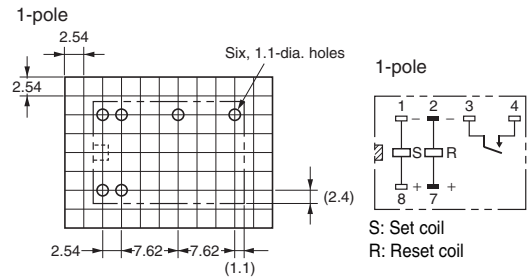

**Flux Protective
Double-winding Latching Model
(Self-clinching PCB)
G6CK-□117C-US**

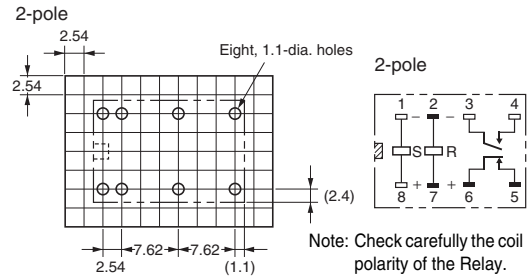
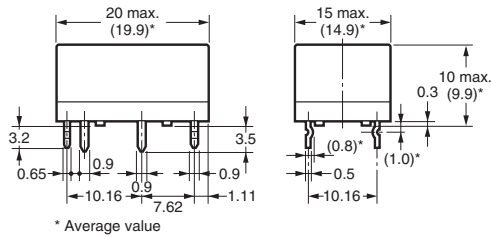
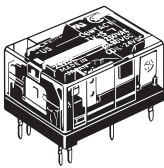

**Fully Sealed
Double-winding Latching Model
(Straight PCB)
G6CK-□114P (-FD) -US**

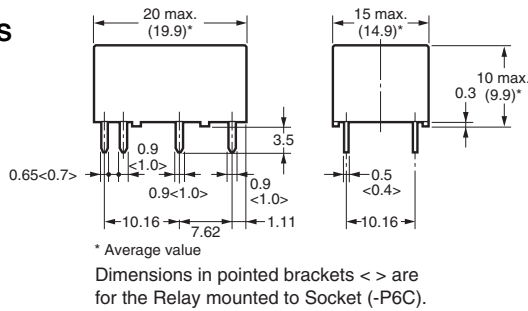
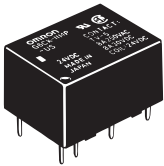

**PCB Mounting Holes
(Bottom View)
Tolerance: ±0.1**

**Terminal Arrangement/
Internal Connections
(Bottom View)**

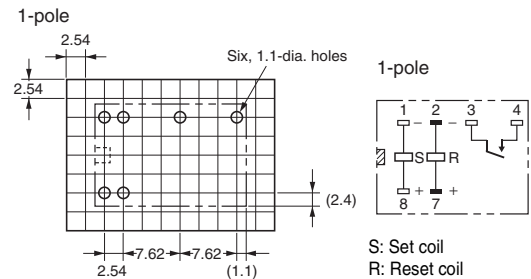

**Fully Sealed
Double-winding Latching Model
(Self-clinching PCB)
G6CK-□114C-US**

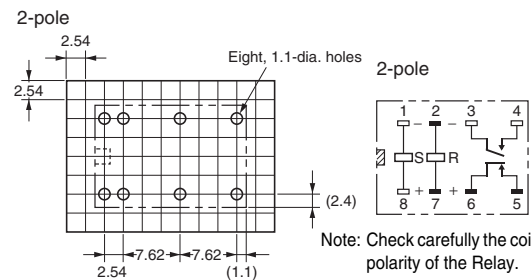
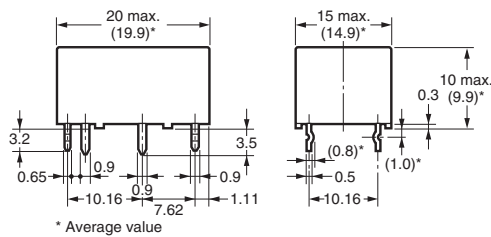
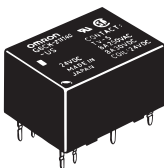

Note: Orientation marks are indicated as follows: □ ▨

■Connecting Sockets Dimensions

Socket for single-winding latching/single-side a table Models

P6C-06P

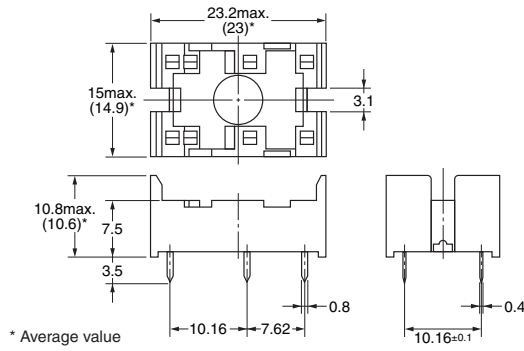
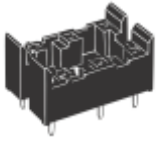

**PCB Mounting Holes
(BOTTOM VIEW)**
Tolerance: ±0.1 mm

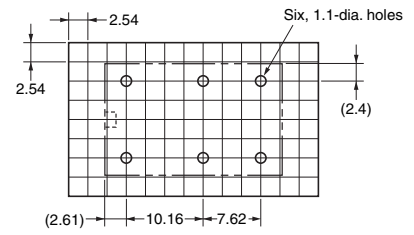

Socket for double-winding latching Models

P6C-08P

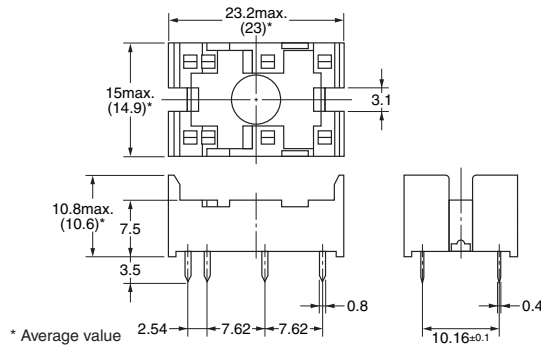
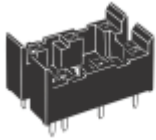

**PCB Mounting Holes
(BOTTOM VIEW)**
Tolerance: ±0.1 mm

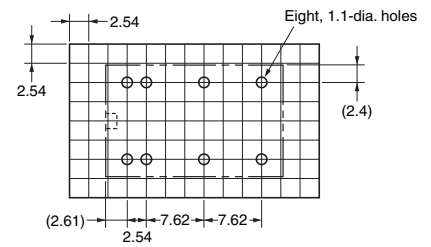

Note: Orientation marks are indicated as follows:

■ Removal Tool

P6B-Y1

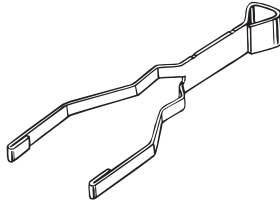

■ Hold-down Clips

P6B-C2

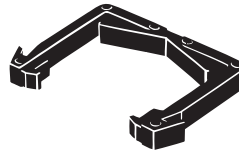

■ Approved Standards

● The rated values approved by each of the safety standards may be different from the performance characteristics individually defined in this catalog.

UL Recognized  (File No. E41643)

CSA Certified  (File No. LR31928)

Model	Number of poles	Coil ratings	Contact ratings	Number of test operations
G6C ()	1	3 to 24 VDC	10 A, 250 VAC (General use) 80°C 10 A, 30 VDC (Resistive) 80°C 1/6 HP 125 VAC, 1/4 HP, 125 VAC 80°C 1/3 HP 250 VAC, 1/4 HP, 250 VAC 80°C 600 W, 120 VAC, (Tungsten) 80°C (excluding -FD Models)	6,000
			530 VA, 20 to 265 VAC Max 2A (Pilot Duty) 80°C 43.2 VA, 30 VDC (Pilot Duty) 80°C	6,000
			12 LRA, 2.2 FLA, 30 VDC 80°C	30,000 1,000 (-FD Models)
	2		8 A, 250 VAC (General use) 80°C 8 A, 30 VDC (Resistive) 80°C 1/6 HP 125 VAC, 1/4 HP, 125 VAC 80°C 1/3 HP 250 VAC, 1/4 HP, 250 VAC 80°C 600 W, 120 VAC, (Tungsten) 80°C (excluding -FD Models)	6,000
			530 VA, 20 to 265 VAC Max 2A (Pilot Duty) 80°C 43.2 VA, 30 VDC (Pilot Duty) 80°C	6,000
			12 LRA, 2.2 FLA, 30 VDC 80°C	30,000 1,000 (-FD Models)

EN/IEC, VDE Certified  (Certificate No. 40014439)

Model	Number of poles	Coil ratings	Contact ratings	Approved switching operations
G6C ()	1	3, 5, 6, 12, 24 VDC	10 A, 250 VAC (cosφ = 1) 40°C 5 A, 250 VAC (cosφ = 0.4) 40°C	20,000
	2	• Single-stable: 3, 5, 6, 12, 24 VDC	7 A, 250 VAC (cosφ = 1) 40°C 3.5 A, 250 VAC (cosφ = 0.4) 40°C	

EN/IEC, TÜV Certified  (Registration No. R50158249)

Model	Number of poles	Coil ratings	Contact ratings	Approved switching operations
G6C ()	1	• Single-stable: 3, 5, 6, 12, 24 VDC	10 A, 250 VAC (cosφ = 1) 40°C 5 A, 250 VAC (cosφ = 0.4) 40°C 10 A, 30 VDC (L/R = 0 ms) 40°C	20,000
	2	• Latching: 3, 5, 6, 12, 24 VDC	8 A, 250 VAC (cosφ = 1) 40°C 3.5 A, 250 VAC (cosφ = 0.4) 40°C 8 A, 30 VDC (L/R = 0 ms) 40°C	

■Precautions

●Please refer to “PCB Relays Common Precautions” for correct use.

Correct Use

●Mounting

- Do not reverse the polarity of the coil (+, -).
- When mounting more than two relays side by side, keep the gap between Relays as shown below to ensure a good heat dissipation. It may result in malfunction if heat is not dissipated smoothly from the Relay.

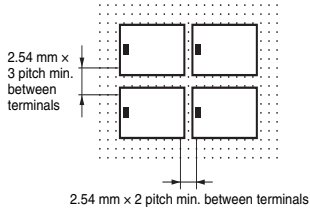

●Sockets

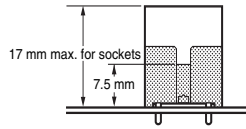

- When mounting the Relay, make sure to insert the Relay terminals perpendicularly and correctly into the socket contact pin.
- Hold-down clips (for mounting and removal) are also available.
- The P6C model has a flux-resistant construction. Do not wash it down with water.
- The max. carry current of sockets is 5A.
- Not applicable to the self-clinching type.

●Double-winding Latching Circuit

- It is recommended to perform wiring of No.1 and No.2 of the negative (-) terminal as COM wiring, in order to improve the operation stability for Double-winding Latching.

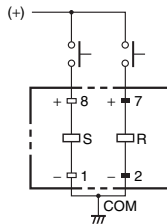

●Using SPDT contact of the SPST-NO+SPST-NC Relay

- Do not construct a circuit so that overcurrent and burning occur if the NO, NC and SPDT contacts are short-circuited with the SPST-NO+SPST-NC Relay. Arcing may generate short-circuiting between contacts if there is short-circuiting because of conversion to the MBB contact caused by asynchronous operation of the NO and NC contacts, the interval between the NO and NC contacts is small, or a large current is left open.

●Other precautions

- This Relay is a Power Relay which is suitable for power load switching. Do not use the G6C for signal purposes such as micro load switching under 10 mA.

Please check each region's Terms & Conditions by region website.

OMRON Corporation

Device & Module Solutions Company

Regional Contact

Americas

<https://components.omron.com/us>

Asia-Pacific

<https://components.omron.com/ap>

Korea

<https://components.omron.com/kr>

Europe

<https://components.omron.com/eu>

China

<https://components.omron.com.cn>

Japan

<https://components.omron.com/jp>

Mouser Electronics

Authorized Distributor

Click to View Pricing, Inventory, Delivery & Lifecycle Information:

[Omron:](#)

[G6C-2114P-US-DC3](#) [G6C-1117P-US-DC5](#) [G6C-2114P-US-DC24](#) [G6C-2114P-US-DC12](#) [G6C-2117P-US-DC12](#)
[G6CK-2114P-US-DC5](#) [G6C-1114P-US-DC12](#) [G6C-1114P-US-DC24](#) [G6C-1114P-US-DC5](#) [G6C-2114P-US-DC5](#)
[G6C-1114P-US-DC3](#) [G6C-1114P-US-DC48](#) [G6C-1114P-US-DC6](#) [G6C-1114P-US-DC9](#) [G6C-1117C-US-DC12](#) [G6C-](#)
[1117P-FD-US-DC12](#) [G6C-1117P-US DC18](#) [G6C-1117P-US-DC3](#) [G6C-1117P-US-DC6](#) [G6C-2114C-US DC3](#) [G6C-](#)
[2114C-US DC5](#) [G6C-2114C-US-DC24](#) [G6C-2114P-FD-US DC12](#) [G6C-2114P-US-DC6](#) [G6C-2114P-US-DC9](#) [G6C-](#)
[2117C-US DC24](#) [G6C-2117C-US DC3](#) [G6C-2117C-US-DC12](#) [G6C-2117P-FD-US DC5](#) [G6C-2117P-FD-US-DC12](#)
[G6C-2117P-FD-US-DC24](#) [G6C-2117P-US-DC24](#) [G6C-2117P-US-DC3](#) [G6C-2117P-US-DC6](#) [G6CK-1114P-US-DC12](#)
[G6CK-1114P-US-DC24](#) [G6CK-1114P-US-DC5](#) [G6CK-1114P-US-DC6](#) [G6CK-1117P-US-DC12](#) [G6CK-1117P-US-](#)
[DC24](#) [G6CK-1117P-US-DC5](#) [G6CK-1117P-US-DC6](#) [G6CK-2114P-US-DC12](#) [G6CK-2114P-US-DC24](#) [G6CK-2114P-](#)
[US-DC3](#) [G6CK-2114P-US-DC6](#) [G6CK-2117P-US-DC12](#) [G6CK-2117P-US-DC24](#) [G6CK-2117P-US-DC3](#) [G6CK-](#)
[2117P-US-DC5](#) [G6CK-2117P-US-DC6](#) [G6CU-1114P-US-DC12](#) [G6CU-1114P-US-DC24](#) [G6CU-1114P-US-DC5](#)
[G6CU-1117P-FD-US DC12](#) [G6CU-1117P-FD-US DC24](#) [G6CU-1117P-FD-US DC5](#) [G6CU-1117P-US-DC12](#) [G6CU-](#)
[1117P-US-DC24](#) [G6CU-1117P-US-DC3](#) [G6CU-2114P-US DC3](#) [G6CU-2114P-US-DC5](#) [G6CU-2117P-US DC3](#)
[G6CU-2117P-US-DC12](#) [G6CU-2117P-US-DC24](#) [G6CU-2117P-US-DC5](#) [G6C-1117P-US DC12](#) [G6C-2117P-US DC8](#)
[G6C-1117P-US-DC24](#) [G6C-2117P-US-DC5](#) [G6CU-1117P-US-DC5](#) [G6C-2114P-US-AP DC12](#) [G6C-2117P-FD-US-SV](#)
[DC9](#) [G6C-2117P-US DC9](#) [G6CU-1114P-FD-US DC5](#) [G6CU-1114P-FD-US-DC3](#) [G6CU-1117P-FD-US DC3](#) [G6C-](#)
[2114P-US-SV DC12](#) [G6C-1117P-US-SV DC24](#) [G6C-1117P-US-P6C DC5](#) [G6C-2114P-US-AP DC24](#) [G6C-2114P-US-](#)
[AP DC3](#) [G6C-2114P-US-AP DC5](#) [G6CK-1114P-FD-US DC12](#) [G6CK-1114P-US DC3](#) [G6CK-1117P-US DC3](#) [G6C-](#)
[2117P-FD-US-SV DC12](#) [G6C-1114P-US-P6C DC12](#) [G6CU-1114P-US-DC3](#) [G6CU-2114P-US-DC24](#) [G6CU-2114P-](#)
[US-DC12](#) [G6CU-1114P-US-DC6](#) [G6C-2114C-US-DC12](#) [G6C-1117P-FD-US DC24](#) [G6CK-2114P-FD-US DC12](#)
[G6CK-2114P-FD-US DC3](#) [G6C-2117P-FD-US DC9](#)